

John Monaco Design

John Monaco
646-410-6487
johnmonacodesign@gmail.com
www.johnmonacodesign.com

702 49th Street 3R
Brooklyn, NY
11220

opening date: 03-11-15

notes:

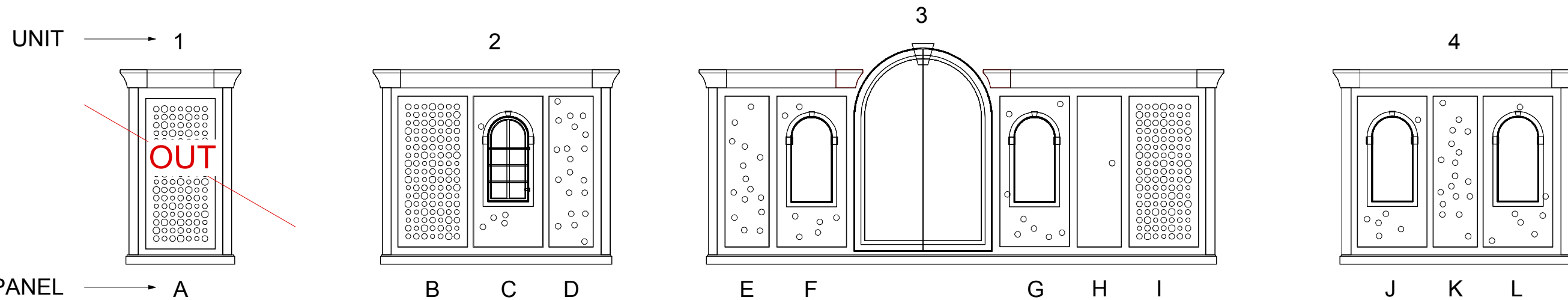

1 NORTH SECTION
Scale: 3/16" = 1'-0"

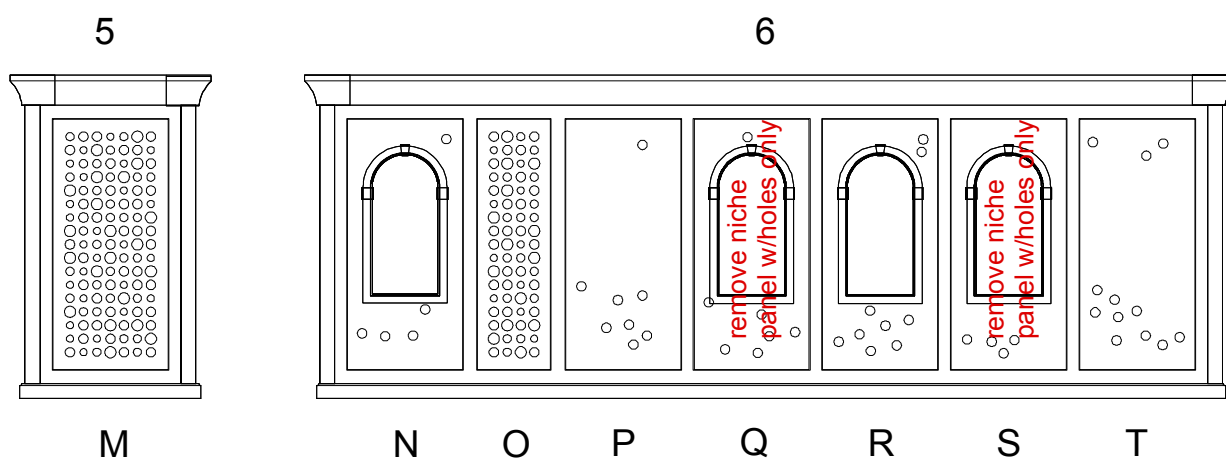

2 EAST SECTION
Scale: 3/16" = 1'-0"

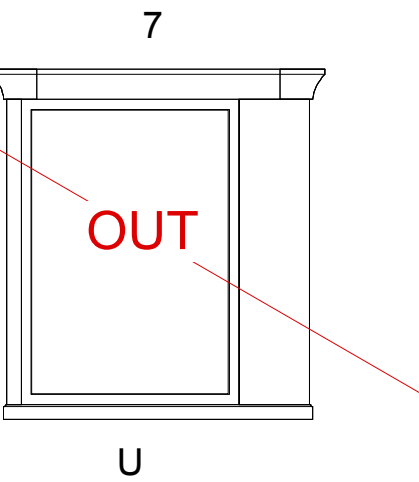

3 TITLE WALL
Scale: 3/16" = 1'-0"

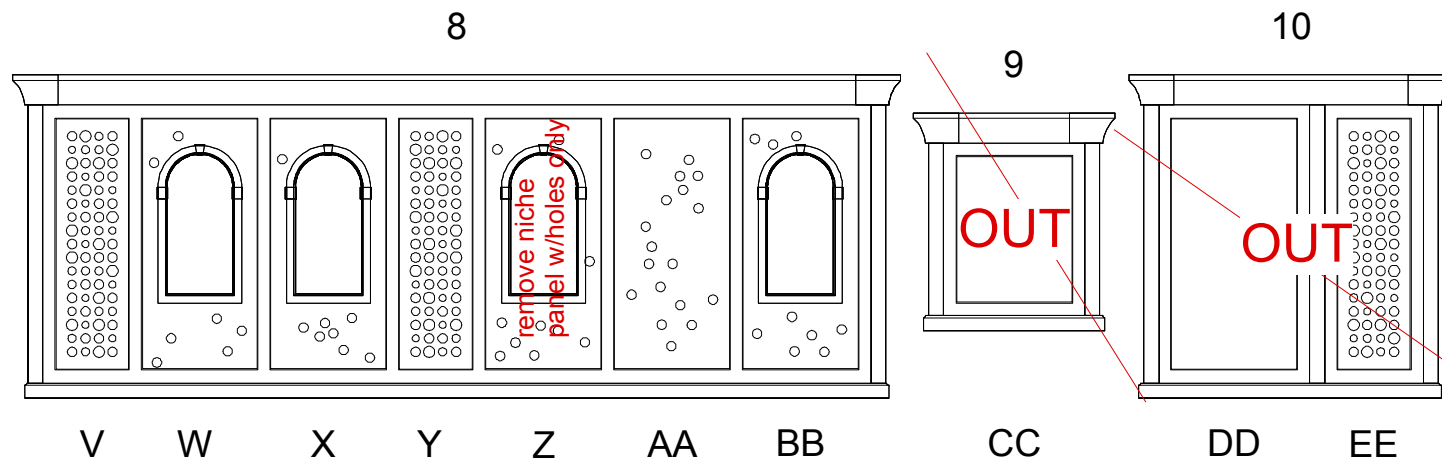

4 WEST SECTION
Scale: 3/16" = 1'-0"

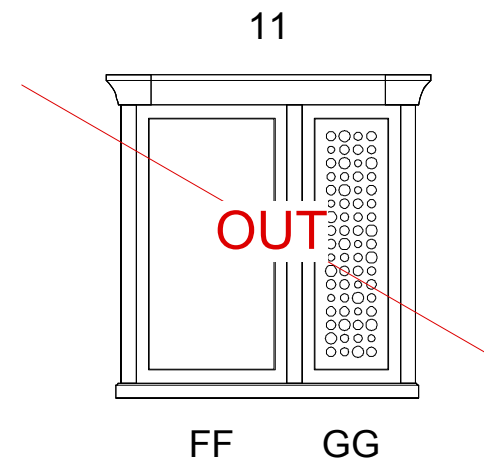

ISSUED/REVISED		
No.	Date	Description
11-25-15		
12-15-15		

DRAWING TITLE
Genesis:
OVERVIEW

Scale
Issue Date
File Name

DRAWING No.

John Monaco Design

John Monaco
646-410-6487
johnmonacodesign@gmail.com
www.johnmonacodesign.com

702 49th Street 3R
Brooklyn, NY
11220

opening date: 03-11-15

notes:

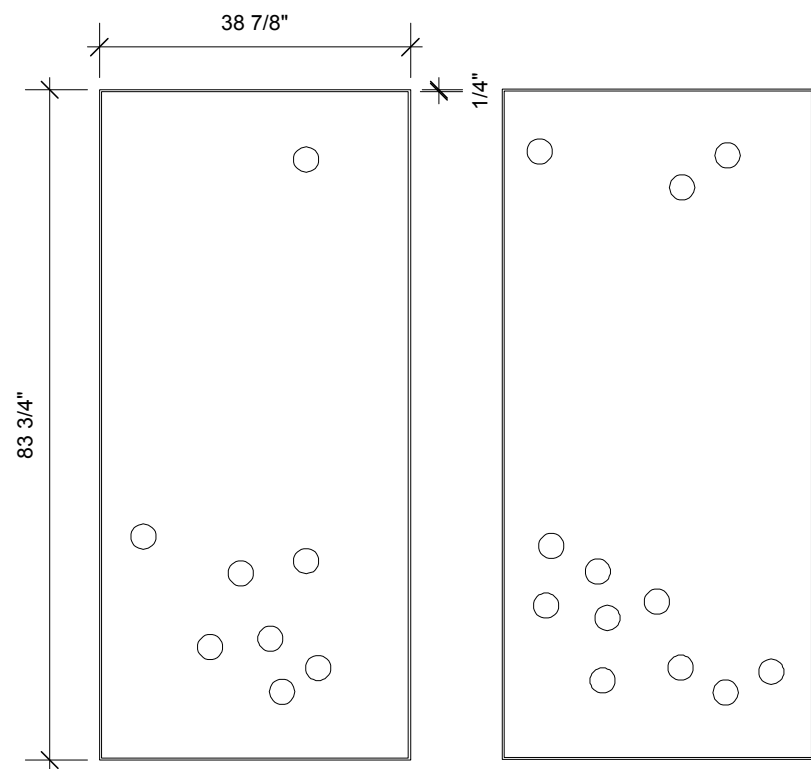

P

T

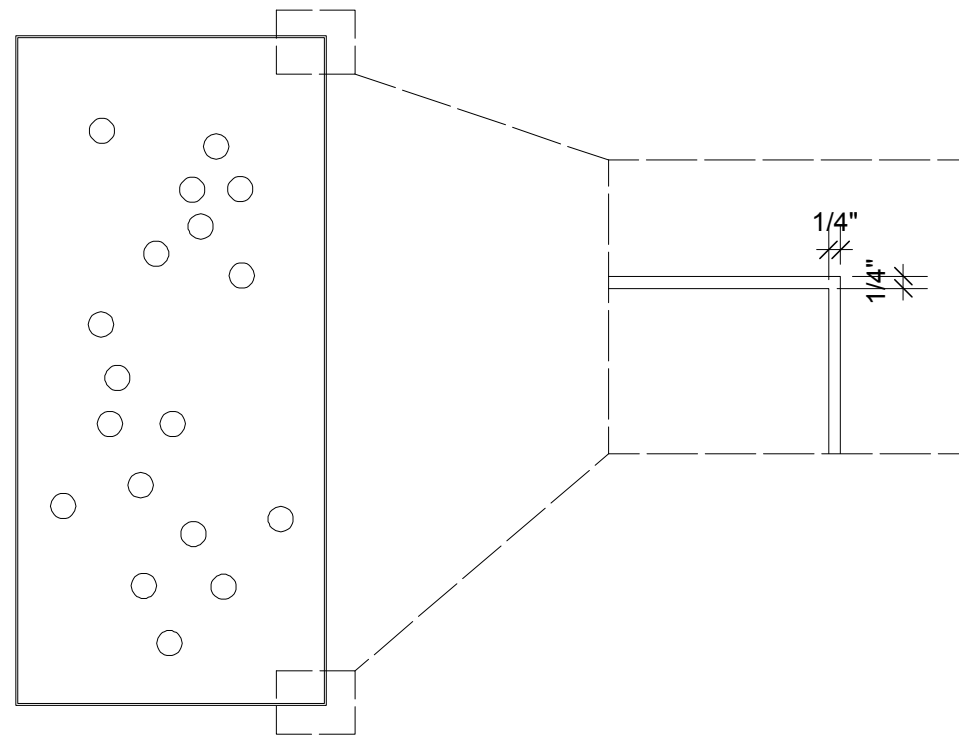

AA

DETAIL FOR ALL PANELS
(p 2 - 5)

ALL PANELS ON THIS PAGE HAVE
THE SAME OUTER DIMENSIONS

REFER TO CUTSHEET DWG FILE

REFER TO "STANDARD LARGE PANEL W/
HOLES CONSTRUCTION"

1 **LARGE PANEL - HOLES IRREGULAR**
Scale: 1/2" = 1'-0"

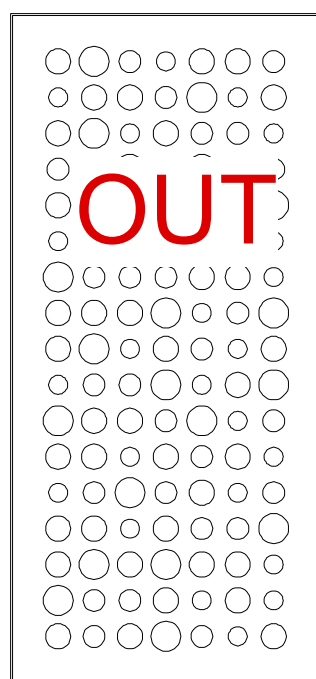

A

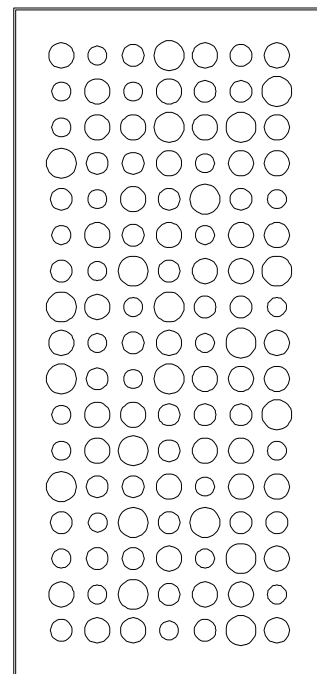

B

SAME HOLE PATTERN AS PANEL "A"
ROTATED 180 DEGREES

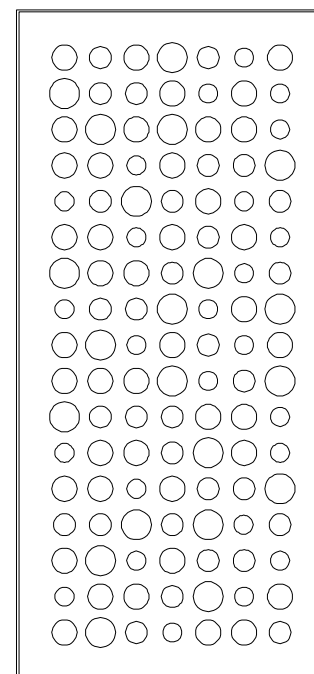

I

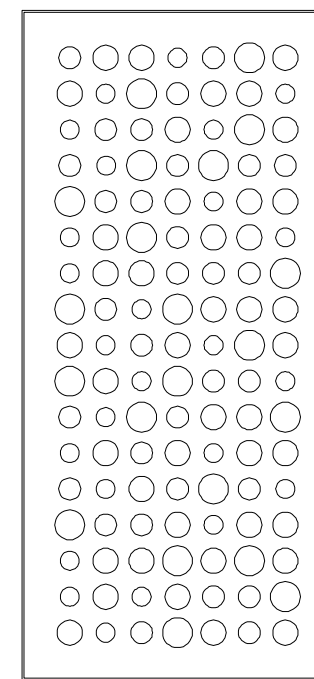

M

SAME HOLE PATTERN AS PANEL "I"
ROTATED 180 DEGREES

2 **LARGE PANEL - HOLES GRID**
Scale: 1/2" = 1'-0"

ISSUED/REVISED		
No.	Date	Description
	11-25-15	
	12-15-15	

DRAWING TITLE
**Genesis: PANELS
LARGE PANELS**

Scale

Issue Date

File Name

DRAWING
No.

John Monaco Design

John Monaco
646-410-6487
johnmonacodesign@gmail.com
www.johnmonacodesign.com

702 49th Street 3R
Brooklyn, NY
11220

opening date: 03-11-15

notes:

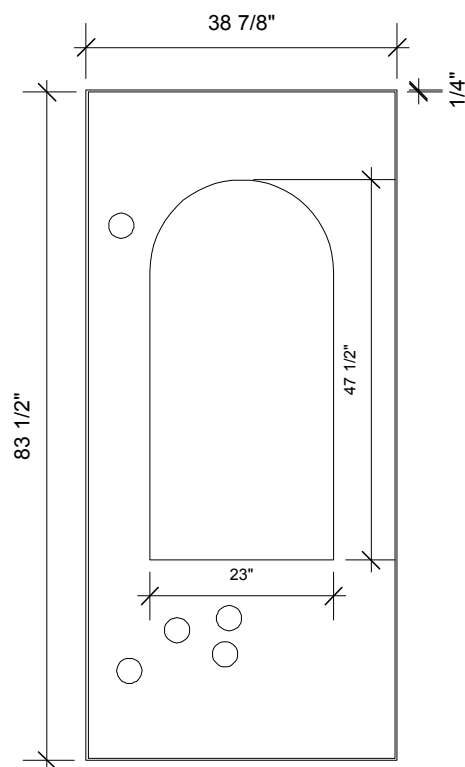

C

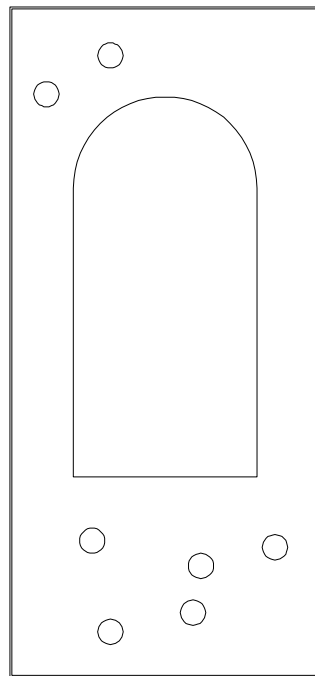

F

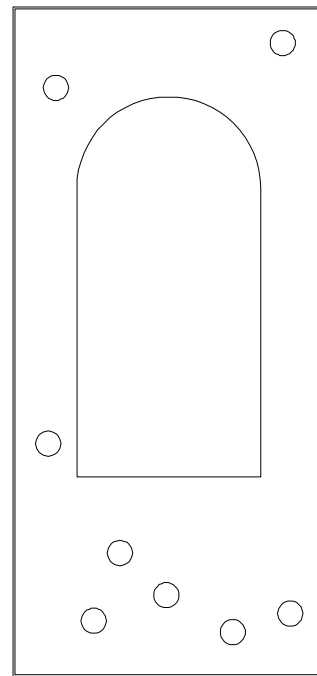

G

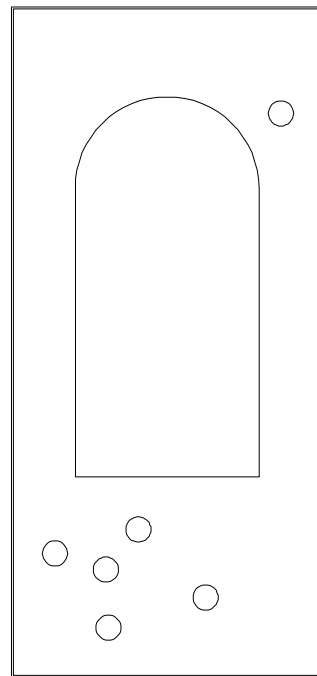

J

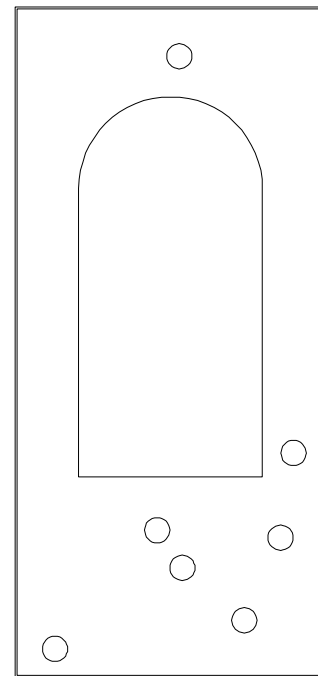

L

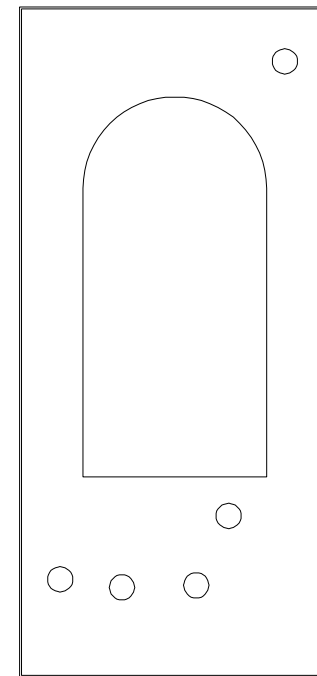

N

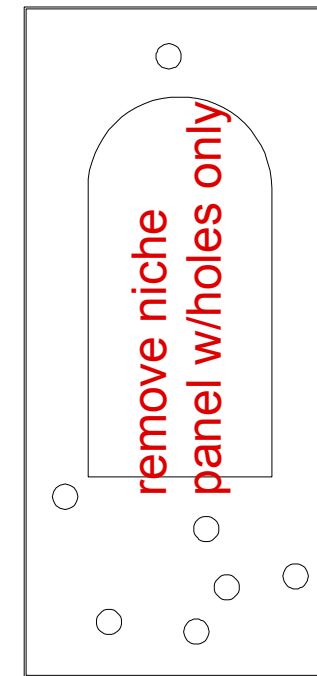

Q

3 **LARGE PANEL - NICHE (W/HOLES)**
Scale: 1/2" = 1'-0"

ALL PANELS ON THIS PAGE HAVE THE SAME OUTER DIMENSIONS

REFER TO CUTSHEET DWG FILE

REFER TO "STANDARD NICHE PANEL CONSTRUCTION"

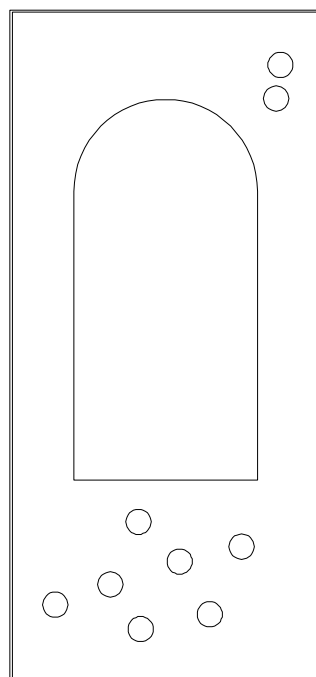

R

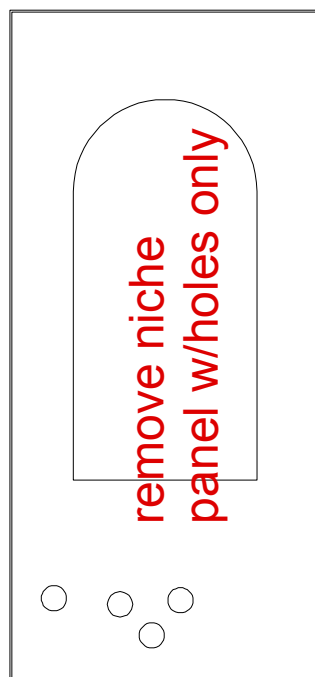

S

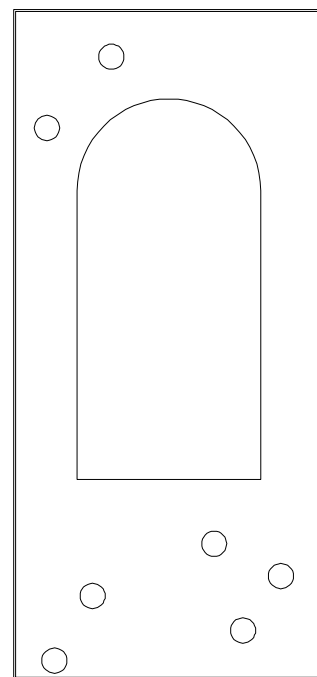

W

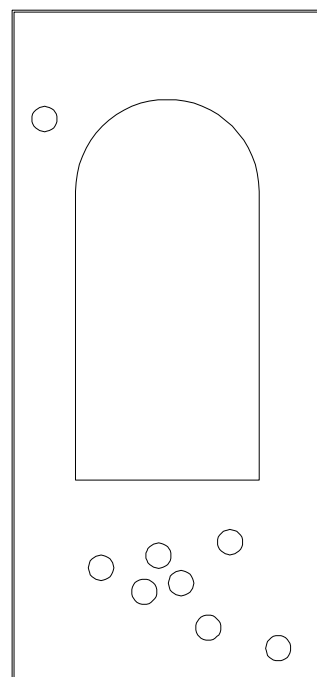

X

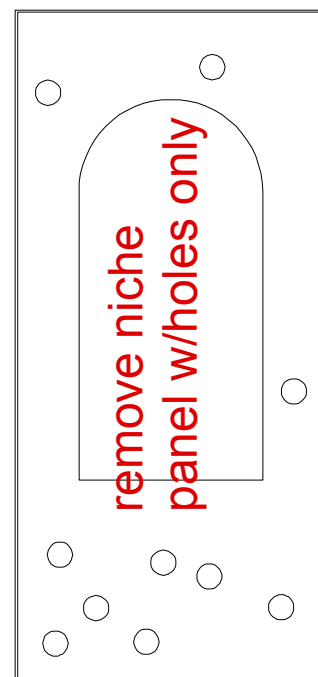

Z

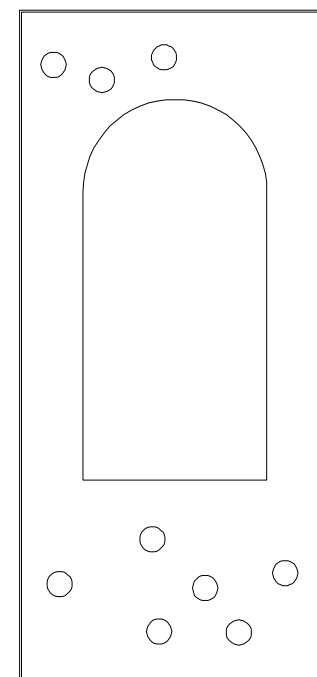

BB

ISSUED/REVISED		
No.	Date	Description
	11-25-15	
	12-15-15	

DRAWING TITLE
Genesis: **PANELS**
LARGE PANELS

Scale

Issue Date

File Name

DRAWING No.

John Monaco Design

John Monaco
646-410-6487
johnmonacodesign@gmail.com
www.johnmonacodesign.com

702 49th Street 3R
Brooklyn, NY
11220

opening date: 03-11-15

notes:

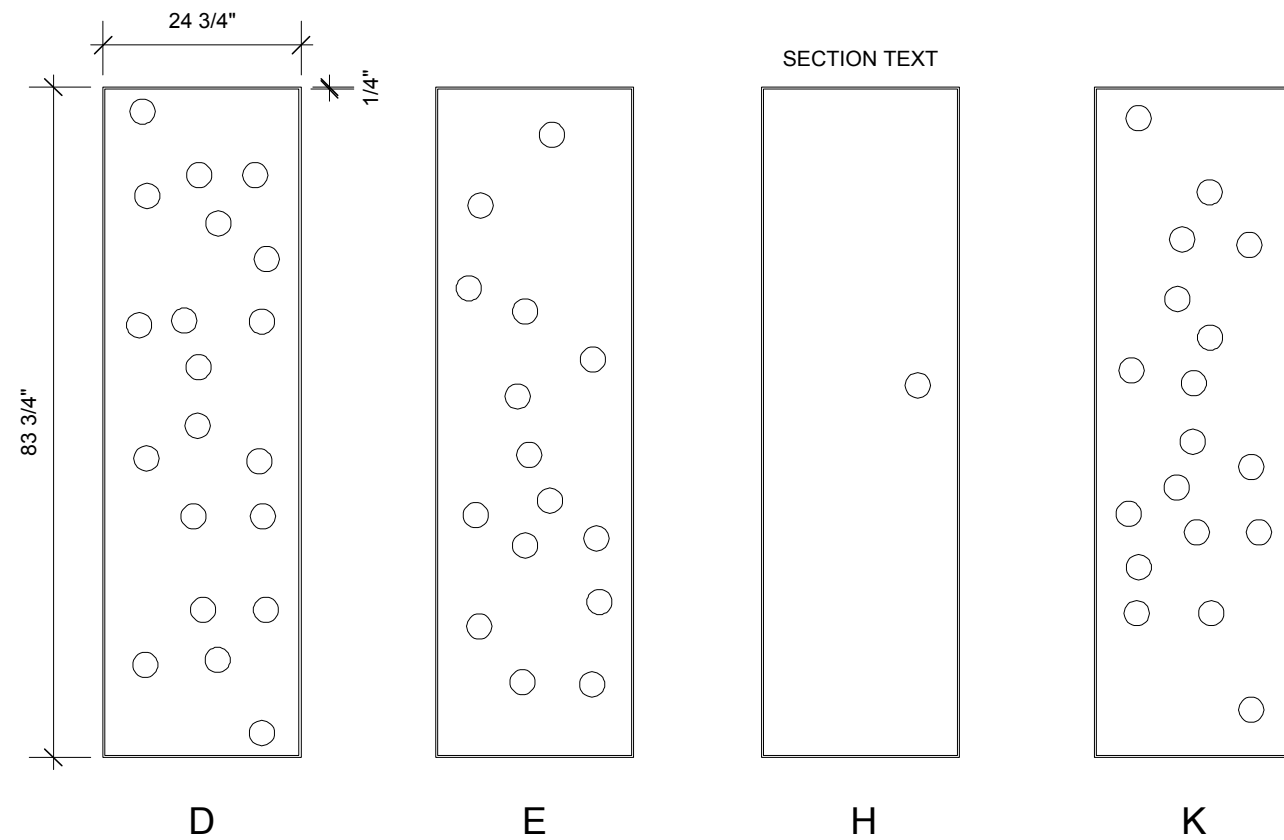

ALL PANELS ON THIS PAGE HAVE THE SAME OUTER DIMENSIONS

REFER TO CUTSHEET DWG FILE

REFER TO "STANDARD SMALL PANEL W/ HOLES CONSTRUCTION"

4 **SMALL PANEL - HOLES IRREGULAR**
Scale: 1/2" = 1'-0"

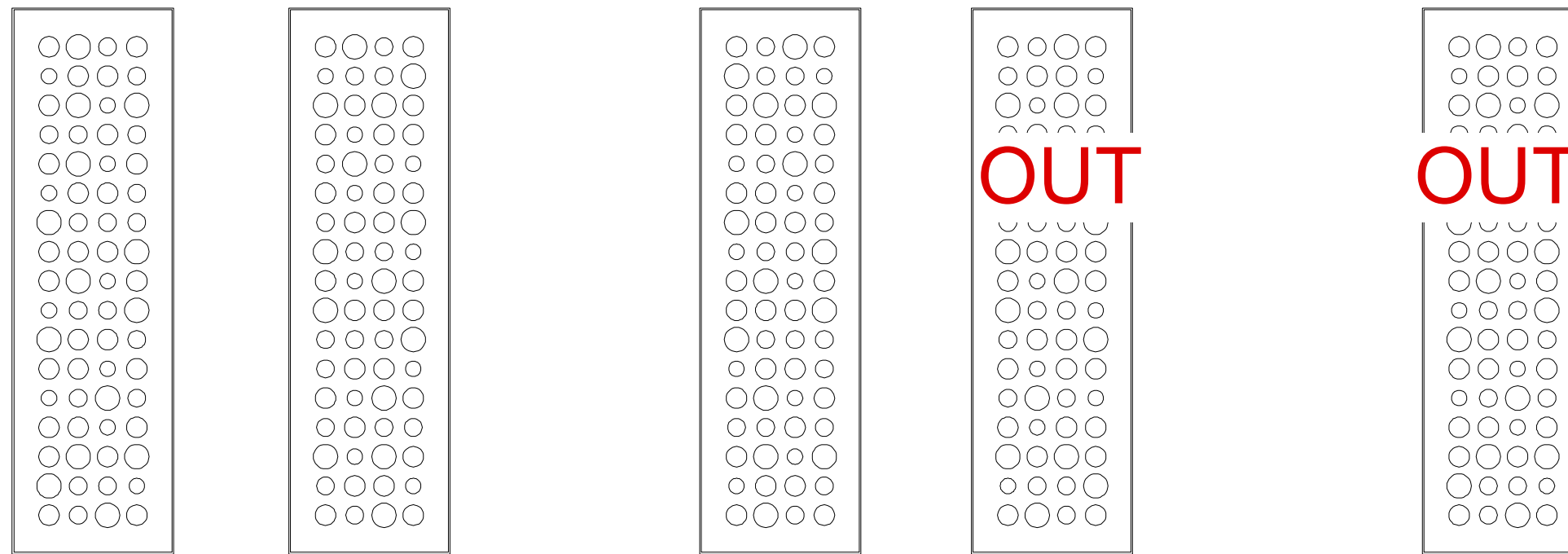

V
SAME HOLE PATTERN AS PANEL "O"
ROTATED 180 DEGREES

EE
SAME HOLE PATTERN AS PANEL "Y"
ROTATED 180 DEGREES

GG
SAME HOLE PATTERN AS PANEL "O"

5 **SMALL PANEL - HOLES GRID**
Scale: 1/2" = 1'-0"

ISSUED/REVISED		
No.	Date	Description
	11-25-15	
	12-15-15	

DRAWING TITLE
Genesis: PANELS
SMALL PANELS

Scale

Issue Date

File Name

DRAWING No.

John Monaco Design

John Monaco
646-410-6487
johnmonacodesign@gmail.com
www.johnmonacodesign.com

702 49th Street 3R
Brooklyn, NY
11220

opening date: 03-11-15

notes:

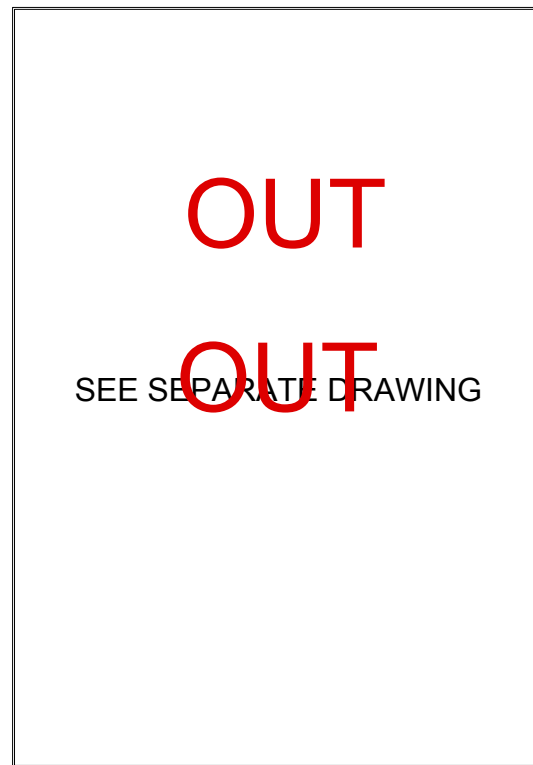

U

6 ATYPICAL PANEL (TITLE WALL) - NO HOLES
Scale: 1/2" = 1'-0"

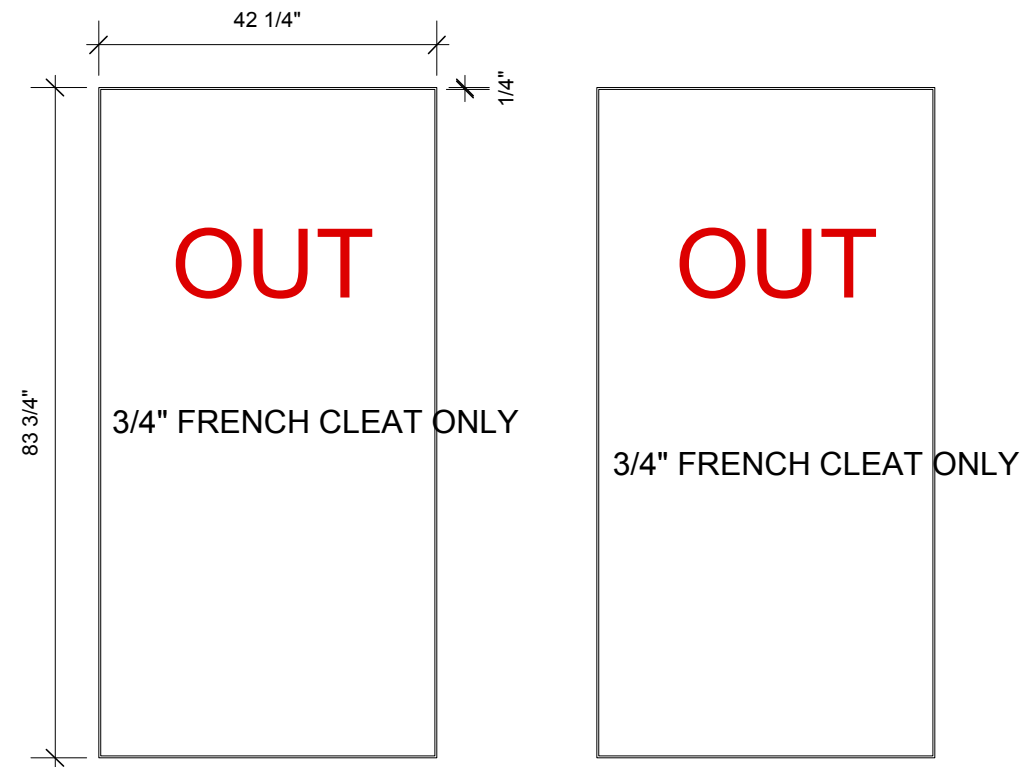

DD

FF

8 LARGE PANEL - NO HOLES
Scale: 1/2" = 1'-0"



CC

7 ATYPICAL PANEL (ABBREVIATED UNIT) - NO HOLES
Scale: 1/2" = 1'-0"

ISSUED/REVISED		
No.	Date	Description
	11-25-15	
	12-15-15	

DRAWING TITLE
Genesis: **PANELS**
ATYPICAL PANELS

Scale

Issue Date

File Name

DRAWING No.

John Monaco Design

John Monaco
646-410-6487
johnmonacodesign@gmail.com
www.johnmonacodesign.com

702 49th Street 3R
Brooklyn, NY
11220

opening date: 03-11-15

notes:

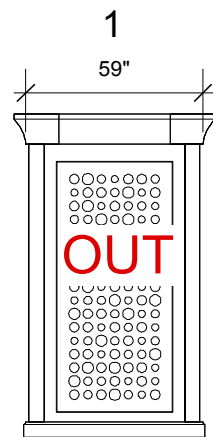

1 NORTH SECTION
Scale: 3/16" = 1'-0"

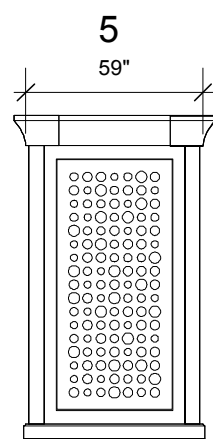
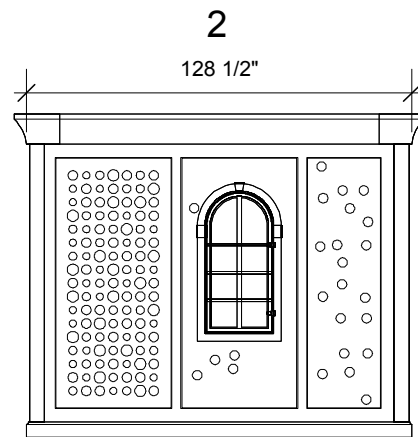

2 EAST SECTION
Scale: 3/16" = 1'-0"

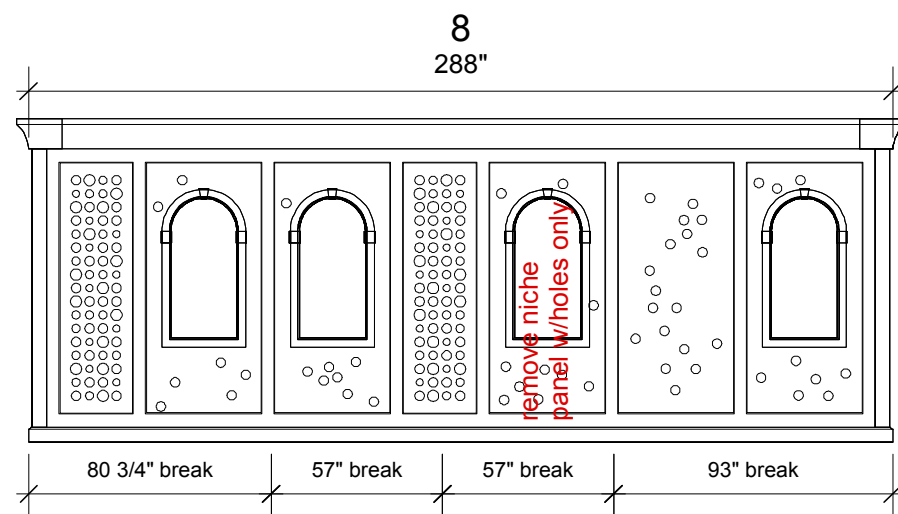
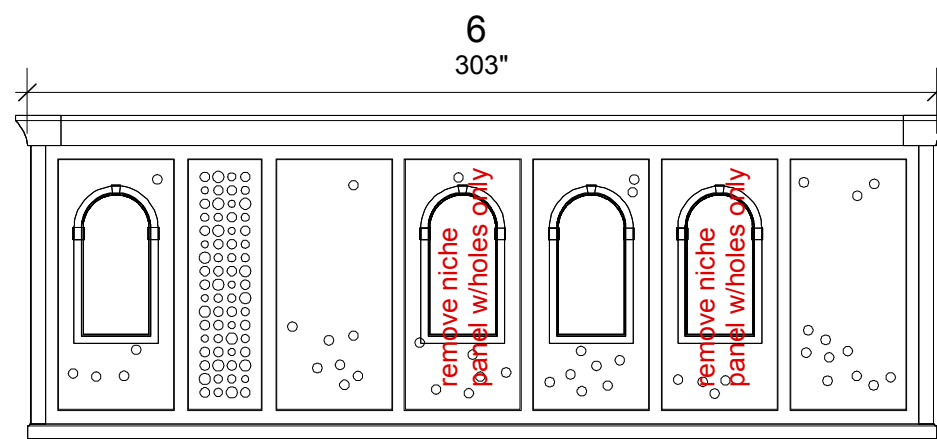

4 WEST SECTION
Scale: 3/16" = 1'-0"

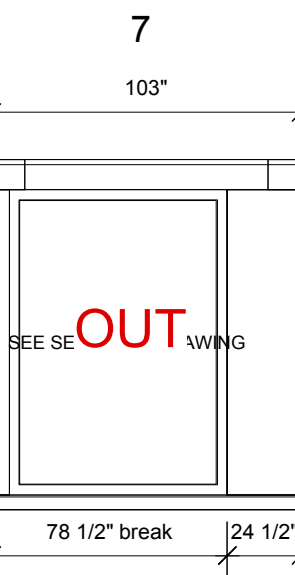
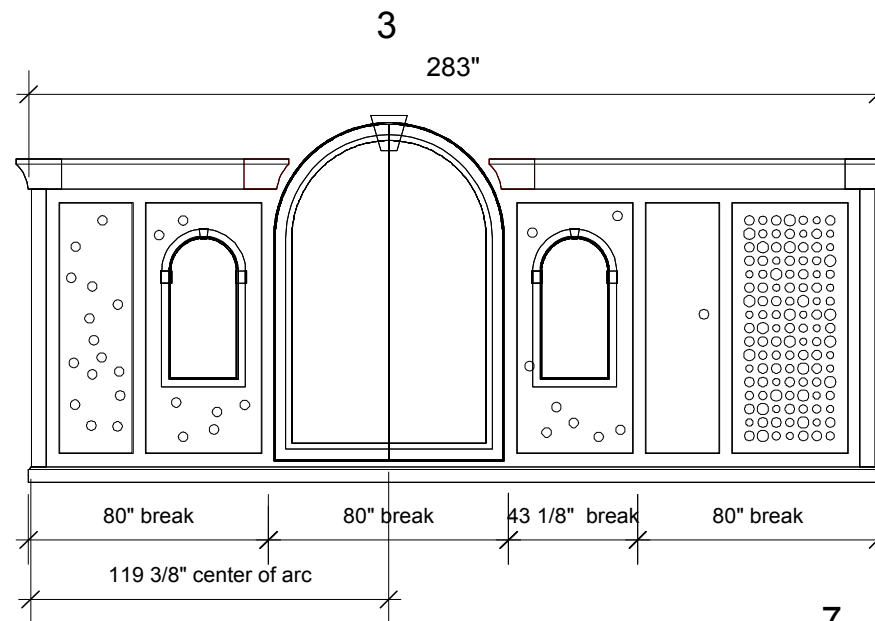

3 TITLE WALL
Scale: 3/16" = 1'-0"

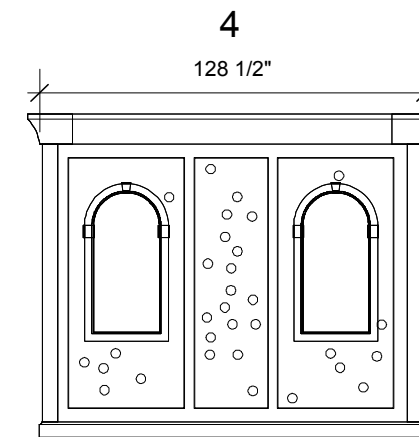

DIMENSIONS CORRESPOND TO DIMENSION "A" ON "TYPICAL CROWN, COLUMN, AND BASE" DRAWING

No Fill on Breaks

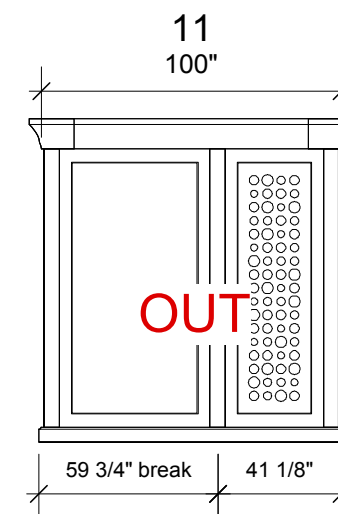
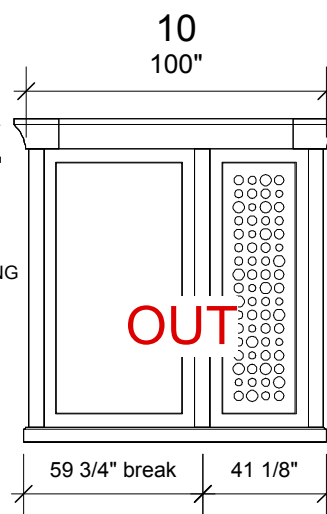
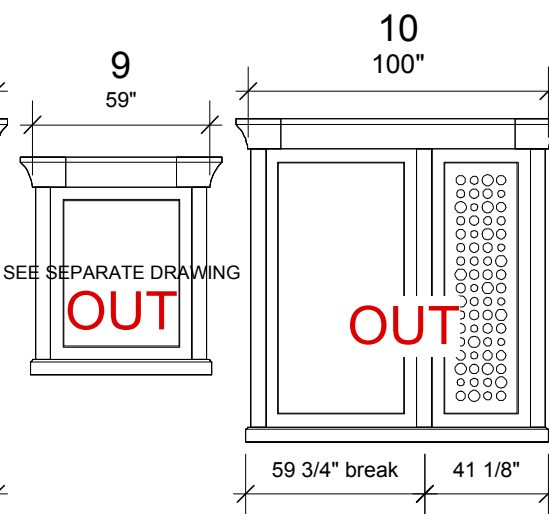

ISSUED/REVISED		
No.	Date	Description
	11-25-15	
	12-15-15	

DRAWING TITLE
Genesis: UNITS
UNIT DIMS.

Scale

Issue Date

File Name

DRAWING No.

John Monaco Design

John Monaco
646-410-6487
johnmonacodesign@gmail.com
www.johnmonacodesign.com

702 49th Street 3R
Brooklyn, NY
11220

opening date: 03-11-15

notes:

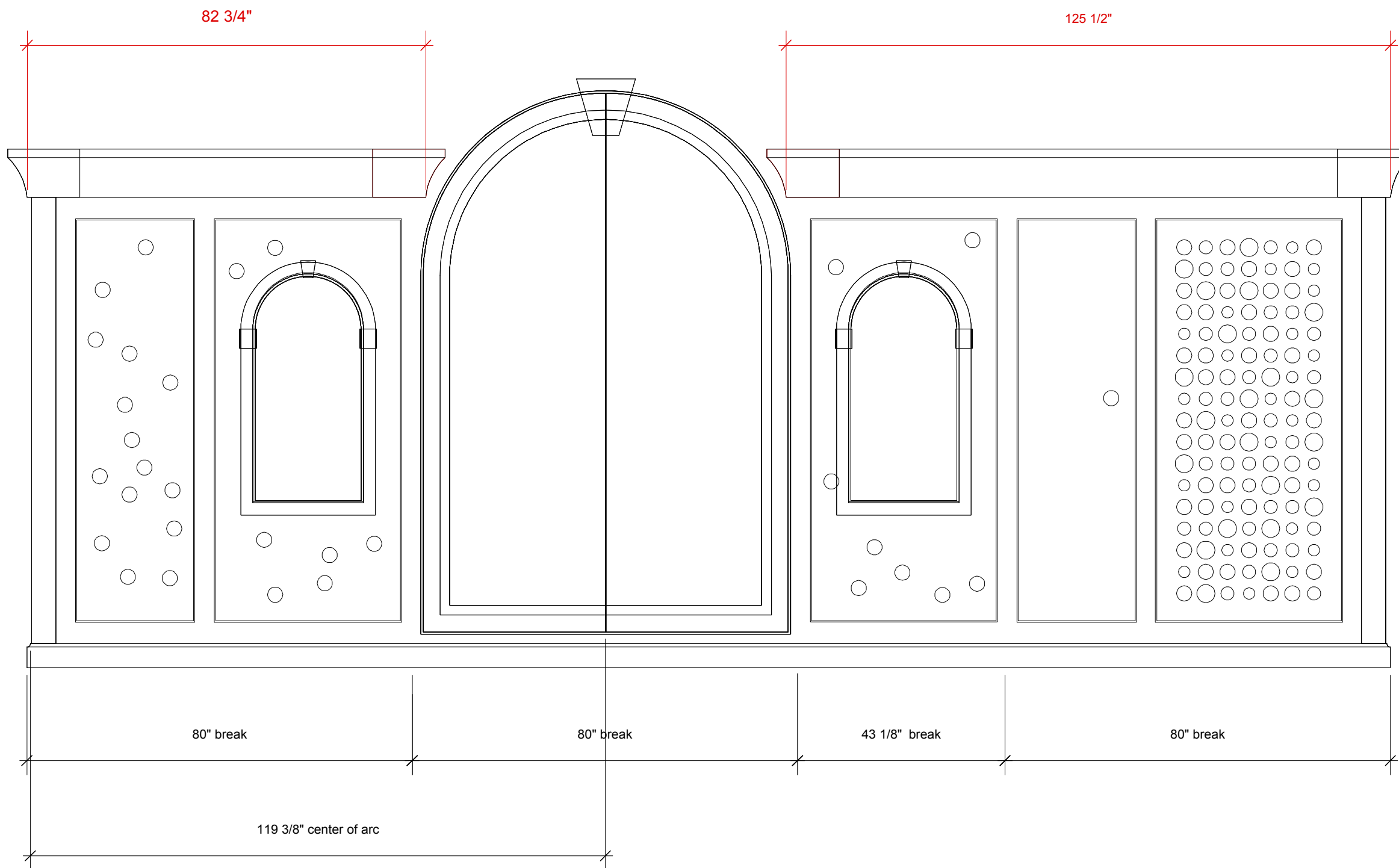

1 NORTH SECTION
Scale: 1/2" = 1'-0"

Wall Unit 3 Crown Revision

ISSUED/REVISED		
No.	Date	Description
	11-25-15	
	12-15-15	

DRAWING TITLE
Genesis:

Scale

Issue Date

File Name

DRAWING No.